



Trade Catalogue 2024



Order on the Trade Website...
www.solartackletrade.com

Welcome

Our passion for fishing and pushing product to the next level is stronger now than ever. Among the new 'toys' we're releasing for 2024 are 3 key new ranges. All designed with the angler in mind and supporting the Solar brand ethos for quality, design and function, at Solar we also develop to support you, the retailer, with healthy margins to support you, the fishing-trade's front line;

SP C-Tech Luggage

*If it bears our **SP C-Tech** marque, it means it's the very best we can craft, with no stone unturned, no corner cut. Our brand **NEW SP C-Tech Luggage** is hewn from **G-Text**, Solar's very own recycled, hi performance fabric, armoured in our revolutionary SolarCam.*

Happiness is a Solar Bedchair

*Our new range of Bedchairs, Sleep Systems and Chairs is headed up by the **New SP C-Tech Bedchairs and Sleep Systems**. Lavishly appointed in 60mm Memory Foam with no expense spared; providing ultimate comfort an performance.*

BlackLite Bankware

*Compact, incredibly good looking and black, the **BlackLite Bankware range** answers the call for the beauty and functionality of our Stainless in a lightweight, alloy version... Exactly what you demand. Now headed by the **BlackLite Version of our Worldwide best seller**, The BlackLite Worldwide delivers '**Solar Performance**' at a fraction of the weight. Using Solar's unique ratchet system (which we've kept in our DNA Stainless Steel so as not mark with the extended usage the Pod is designed for), the height is adjustable, along with the length and the width to answer most fishing situations.*



Order on the Trade Website...
www.solartackletrade.com

New from Solar...



SP C-Tech Luggage



SP C-Tech Bedchairs & Chairs



BlackLite Bankware



Order on the Trade Website...
www.solartackletrade.com

BIRDS & SHEETERS

BENCHES
SEVER SYSTEMS
& CHAIRS

LUGGAGE &
ACCESSORIES

FISHCAIR

LANDING NETS

HOT SPOTHEAT

SOLAR
BANKWARE

PT SPINLESS
BANKWARE

BLACKLITE
BANKWARE

AL ALUMINIUM
BANKWARE

SOLAR SYSTEM BITE
INDICATION

SOLAR
MANLINES

HOOBS & RIG TOOLS

THE SMALL
PRINT

Contents

SOLAR 2024
CONTENTS

SECTION NUMBER

<i>Bivvies & Shelters</i>	1
<i>Bedchairs, Sleep Systems & Chairs</i>	2
<i>Luggage & Accessories</i>	3
<i>Fishcare</i>	4
<i>Landing Nets</i>	5
<i>HotSpot Heat</i>	6
<i>Solar Barrows</i>	7
<i>P1 Stainless Bankware</i>	8
<i>BlackLite Bankware</i>	9
<i>A1 Aluminium Bankware</i>	10
<i>Solar System Bite Indication</i>	11
<i>Solar Mainlines</i>	12
<i>Hooks & Rig Tools</i>	13
<i>The Small Print</i>	14

Bivvies & Shelters

SP UNiSpider



SP Uni Spider Bivvy System (Includes Zip-In Groundsheet & Infill Panel)

SP Uni Spider Shelter

- Part of our "Solar System" Modular Concept, which means the UNI Spider expands with your fishing
- Equally as happy as a broly or the bedroom module in a long-stay system
- "Quick Up" Spider frame, super-fast set-up
- SolarTex D Material
- Optimum space is achieved via square footprint
- 4 blind and mesh, zipped windows
- Twin Skin Top Membrane limiting condensation build-up
- Snap-Loc Full System, magnetic fittings including rod ties and windows
- Solar DNA Stainless effect Spreader Block
- Complete with hard-wearing, zipped carry bag
- Weight: 10.06kg

SP Uni Spider Infill Panel

- Converts the UNI Spider shelter into the perfect bivvy
- SolarTex D Material
- Snap-Loc magnetic buckles for swift, painless set-up
- Multiple door/window options via blinded, mozzie-mesh windows and roll-up front and clear window
- Weight: 1.2kg

SP Uni Spider Zip In Groundsheet

- Heavyweight construction to endure the roughest terrains, time and time again
- Quality, chunky, easy-flo zip
- Tailored to fit the SP UNI Spider perfectly
- Weight: 2.44kg

CODE	PRODUCT NAME	UNIT	SP	BP
001	SP UNi Spider Bivvy System	1		





UNI Spider



South Westerly Pro Uni Spider Bivvy System (Includes Zip-In Groundsheet & Infill Panel)

South Westerly Pro Uni Spider Shelter

- "Quick-Up" Spider frame suer-fast set-up
- SolarTex 3 material
- Snap-Loc system, magnetic fittings for swift, painless set-up
- Nylon Solar Block
- 4 blind and mesh windows
- Optimum space is achieved via square footprint
- Twin Skin Top Membrane limited condensation build-up
- Complete with hard-wearing, zipped carry bag
- Weight: 8.94kg

South Westerly Pro Uni Spider Infill Panel

- Converts the UNI Spider shelter into the perfect bivvy
- SolarTex 3 Material
- Snap-Loc magnetic buckles for swift, painless set-up
- Multiple door/window options via blinded, mozz-mesh windows and roll-up front and clear window
- Weight: 1.1kg

South Westerly Pro Uni Spider Clip-In Groundsheet

- Heavyweight construction to endure the roughest terrains, time and time again
- Quality, chunky dips
- velcro corner seals
- Tailored to fit the South Westerly Pro UNI Spider perfectly
- Weight: 2.1kg

PRODUCTS TIME SP RP



UNI Spider



Uni Spider 0.5m/1.2m Extended Wrap Green (Compatible With Both SP And South Westerly Pro Models)

- Part of our "Solar System" Modular Concept, which means the UNI Spider expands with your fishing
- Converts the UNI Spider bivy into the perfect long-stay shelter
- Acts as a twin skin to improve heat retention and eliminate condensation
- SolarTex 3 Material
- Delivers a bivy-wide 0.5m long porch, perfect for storage, cooking and socialising
- Multiple door/window options via roll-up blind and clear window panel
- Snap-Loc System, magnetic fittings for swift, painless set-up
- Robust, alloy, extending frame
- Complete with hard-wearing, carry bag
- Weight: 6.22kg



Mozzie Mesh Front Door (Compatible With Both SP And South Westerly Pro Models)

- Part of our "Solar System" Modular Concept, which means the UNI Spider expands with your fishing
- Self-closing Snap-Loc magnetic system (another Solar industry first) means the mesh ALWAYS shuts, to totally eliminate bugs getting in



Uni Spider Peak (Compatible With Both SP And South Westerly Pro Models)

- Part of our "Solar System" Modular Concept, which means the UNI Spider expands with your fishing
- Delivers a peak and a thermal layer to eliminate condensation, retain heat and keep you in the dry or shade
- SolarTex 3 Material
- Robust, alloy, extending frame
- Quick, simple attachment (all necessary fittings included)
- Complete with hard-wearing, carry bag
- Weight: 1.24kg



Camo Compact Spider System (Shelter, Infill Panel, Groundsheet)

Compact Spider Heavy Duty Groundsheet

- Heavy-duty, hard wearing construction
- Full, zip-in attachment to completely protect you and your gear
- Quick and easy to zip in/out
- Designed for the SP Compact Spider Shelter
- Durable, heavy-duty zip
- Weight: 8.46kg



Camo Compact Spider Infill Panel

- Made from SolarTex material
- Full, zip-in front infill panel
- Quick and easy to zip in/out
- Featuring our unique Snap-Loc Buckles
- Multiple set-up options, including 'letterbox' style
- Mozzi-mesh door option
- Weight: 1kg

Camo Compact Spider Shelter

- Ultra-adaptable, one man shelter
- Add optional extras to tailor the perfect system
- High-grade, SolarTex Fabric
- Adjustable frame mechanism utilising a Cam-Loc system on each frame leg for ultimate flexibility
- Square rear profile allows for maximum internal space and headroom
- Internal condensation cap
- Snap-Loc buckles
- Storm poles included
- Full, mozzie mesh front with Snap-Loc door and zip-in groundsheet available separately
- Lightweight and compact, while remaining spacious and stable
- Solar DNA Metal Spreader Block
- PermaVents





SP Quick-Up Shelter Green MkII With Heavy-Duty Groundsheet

- Improved design for 2023
- The most versatile shelter on the market!
- Perfect for one or two anglers or as a cook/social tent
- Heavy-duty, rip-stop groundsheet
- Quick Up Construction via the Easy-Loc Leg System
- Peak over doors
- Vented Twin Skin Roof with built in climate control vent
- Square footprint maximises usable space
- Front and rear doors
- Made from SolarTex Fabric





SP Quick-Up Shelter MkII Overwrap

- Overwrap for our hugely-popular Quick-Up Shelter
- Compatible with both the Quick-Up MKII model and our original Quick-Up Shelter
- Provides a second skin and also a porch area
- Supplied with an easy-fit bracket (and fitting instructions) for use with our original Quick-Up Shelter
- Supplied with an adjustable tension bar to provide rigidity to the roof of the porch area
- Roll-up front door
- Cut out for access to the rear door (our Quick-Up Shelter has front and back doors!)
- Made from SolarTex Fabric
- Four guy ropes interwoven with reflective cord so you can avoid them at night
- Pack-away guy ropes, for neat and tidy storage easier pack down / set up
- Four Velcro rod ties on the front
- Supplied in a storage / carry bag



SP 6-Hub Cube Shelter

- Made from our SolarTex material
- Set up in less than 1 minute using the Push-Loc Hub design
- 6 sides, creating a huge internal space
- All sides have full-fabric covers which can be rolled up, leaving mozzie mesh sides to suit any situation/configuration
- Heavy-duty groundsheet available separately
- Includes the Solar-first Mag-Loc door system
- 2 doors, one on either side. You can put a biwiy on the back of this shelter
- Doors with removable fiberglass poles for rigidity and conversion into canopies



Sets up in less than a minute!



SP 6-Hub Cube Shelter Heavy-Duty Groundsheet

- Heavy-duty, hard wearing construction
- Quick and easy Velcro-in attachment for complete protection

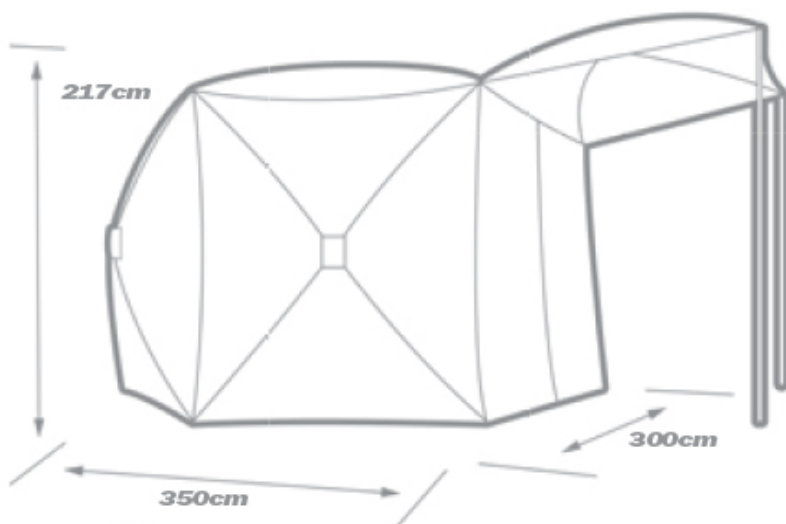

Order on the Trade Website...
www.solartackletrade.com



SP Cube Shelter MkII

- The perfect social/ cook tent or long stay shelter
- Ultra fast, 30 second set-up!
- Maximum space and headroom
- Multiple door configurations
- Protection or ventilation for all weathers
- Improved, rigid extended porch for storage and cover
- The perfect long-stay bivvy or social/cook tent

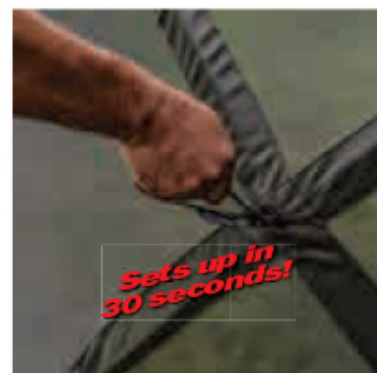

Order on the Trade Website...
www.solartackletrade.com



UnderCover Camo Brolly System

- Ultra versatile, for a night or a week!
- Available in UnderCover Camo or Green 10,000HH material
- Lightweight featuring 8.5mm HD Fibreglass poles
- Huge rear meshed window for ventilation
- Low-profile spoke system
- Flat back to accommodate bedchair
- Multiple door/vent combinations
- Maximum internal space
- Supplied in bespoke carry case
- Supplied with storm poles and heavy-duty pegs.

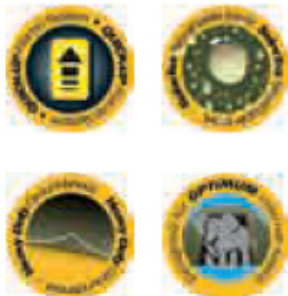

Bedchairs, Sleep Systems & Chairs



UnderCover Camo Foldable Easy Chair - Low

- Cross-folding frame for compact storage/transport
- Supplied in an UnderCover Camo storage bag
- Adjustable legs
- Two Duplon arm rests
- 600D, PVC backed, camouflage fabric
- Low-profile design
- Perfect for the roving or river angler
- Dimensions: 39 x 52 x 23cm
- Weight: 3.12kg

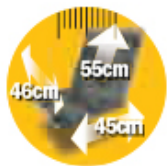

3.2kg



UnderCover Camo Recliner Chair

- Padded mattress with 600D, PU backed, camouflage fabric
- Seven-point recline system, adjusted via the arm rests
- Ergonomic arm rests
- Adjustable legs
- Solar mud feet
- Fold-flat design
- Dimensions: 48 x 55 x 40cm
- Weight: 5.78kg

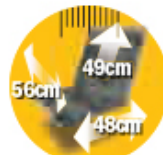

5.66kg



New!

SP C-Tech SuperLite Chair

- 3D Dura-Dore Mattress
- Oversized, reinforced tubular frame
- Oversized, oval legs
- Full, high-tensile aluminium frame
- Spring-Loc leg system
- SolarCam camo pattern
- Dimensions: 52 x 52 x Seat: 25, Back: 53cm
- Weight: 5.6kg



New!

SP C-Tech SuperLite Low Chair

- 3D Dura-Dore Mattress
- Oversized, reinforced tubular frame
- Oversized, oval legs
- Full, high-tensile aluminium frame
- Spring-Loc leg system
- Arm rests
- SolarCam camo pattern
- Dimensions: 53 x 42 x Seat 33, Back: 41cm
- Weight: 5kg



SP C-Tech Sofa Chair

- *The ultimate in session chair comfort!*
- *Featuring SP C-Tech Digital SolarCam*
- *3D Dura-Dore air-pocketed, self ventilating mattress*
- *Incredibly lightweight*
- *High tensile, aluminium folding frame*
- *Spring-Loc leg adjustment (another Solar first!)*
- *Swivelling mudfeet*
- *Ergonomic, padded arm rests*
- *Compression straps to keep the chair closed in transit*
- *Front and rear Legloc to prevent collapse under lateral movement*
- *Dimensions: 91 - 101 x 80cm*
- *Weight: 5.9kg*

SP C-Tech Compact Sofa Chair

- *The ultimate in session chair comfort!*
- *Features SP C-Tech Digital SolarCam*
- *3D Dura-Dore air-pocketed mattress*
- *High tensile, lightweight, aluminium folding frame*
- *Spring-Loc leg adjustment (another Solar first)*
- *Swivelling Mudfeet*
- *Ergonomic, padded arm rests*
- *Leglock buckle fastening to keep the chair closed when folded*
- *Both front and rear leg securing clips to prevent the legs from collapsing while in use*
- *Dimensions: 75 - 85 x 47 x 52cm*
- *Weight: 5.15kg*





New!

SP Recliner Chair MKII - High

- High-tensile, lightweight aluminium frame
- 3D Dura-Dore, air-pocketed mattress
- Spring-Loc leg system
- 4-point recline system
- Dimensions: 53 x 45 x Seat: 46cm, Back: 68 cm
- Weight: 5.9kg

New!

SP Recliner Chair MKII - Low

- High-tensile, lightweight aluminium frame
- 3D Dura-Dore, air-pocketed mattress
- Spring-Loc leg system
- 4-point recline system
- Dimensions: 54 x 44 x Seat: 35, Back 64cm
- Weight: 5.7kg





New!

**South Westerly Pro
SuperLite Recliner
Chair**

- Lightweight, aluminium frame
- Fully reclining
- Spring-Loc legs on the front
- UnderCover Camo
- Dimensions: 51 x 50 x Seat: 37, Back: 70cm
- Weight: 4.1kg

New!

**South Westerly Pro
Combi Chair (Bed-Fit &
Recline)**

- Dual-use chair. Can be fitted a top a bedchair and used as a stand-alone session chair.
- Lightweight, aluminium frame
- Fully reclining
- Spring-Loc legs on the front
- UnderCover Camo
- Dimensions: 54 x 44 x Seat: 35, Back: 64cm
- Weight: 5.1kg





UnderCover Camo Session Chair

- Padded mattress with 600D, PU-backed, camouflage fabric
- The mattress features Solar's unique lumbar support system with the mattress integrated into the frame
- Adjustable legs
- Velcro fastening straps to keep the chair closed when packed away
- Multi-point, hand-wheel recline system
- Both front and rear securing clips to prevent the legs from collapsing while in use



5.14kg



4.8kg



UnderCover Camo Folding Chair - High

- Cross-folding frame for compact storage/transport
- Supplied in an UnderCover Camo storage bag
- Adjustable legs
- Two Duplon arm rests
- 600D, PVC backed, camouflage fabric
- Solar mud feet



South Westerly Moon Chair

- Easy fold/unfold frame mechanism
- Luxurious padded upholstery for ultimate comfort
- UnderCover Camo
- Pack-away straps
- Carry handle
- Supplied in toggled carry bag
- Dimensions: 82 x 92 x 86cm
- Weight: 5.3kg



UnderCover Camo Bedchair

- Solar quality built-in
- Padded mattress with 600D, PVC backed, camouflage fabric
- Twin-pivot hinges to allow the bedchair to fold flat, even with a sleeping bag attached
- Retention strap to hold legs in place and bed closed when packed away
- 6 adjustable legs
- Solar mud feet
- Dimensions: 205 x 73 x 36cm
- Weight: 8.97kg



UnderCover Thermal Bedchair Cover

- Another Solar first! The Cover features a thermal silver lining designed to reflect and retain maximum heat
- Showerproof bedchair cover
- UnderCover Camo pattern
- Features bedchair attachments (webbing straps and clips) to attach to any bedchair frame
- Will fit all popular 'standard' width bedchairs and sleep systems
- Dimensions: 225 x 98 x 19cm
- Weight: 1.2kg

New!



SP C-Tech Memory Foam Sleep System MKII

- Memory 6 Mattress
- Layflat lumbar support, with the mattress built into the frame
- Dual-layer, 5-season duvet system
- SolarTex D, waterproof 20k outer material
- Oversized Baffle
- Flat-Pac hinge system
- Oversized, reinforced tubular frame
- Oversized, oval legs
- Full, high-tensile aluminium frame
- Spring-Loc leg system
- Easy slide, anti-snag zips
- SolarCam camo pattern
- Pac-Away compression straps and carry handle
- Dimensions: 208 x 89 x 40-52cm
- Weight: 19.4kg

New!



SP 3D Dura-Dore Sleep System

- Layflat lumbar support, with the mattress built into the frame
- Dual-layer, 5-season duvet system with PeachSkin material
- Oversized Baffle
- Flat-Pac hinge system
- Oversized, reinforced tubular frame
- Oversized, oval legs
- Full, high-tensile aluminium frame
- Spring-Loc leg system
- Layflat lumbar support
- Easy slide, anti-snag zips
- Pac-Away compression straps and carry handle

STANDARD:

- Dimensions: 208 x 100 x 40-52cm
- Weight: 14.7kg

 New!

SP C-Tech Memory Foam Bedchair MKII

- Memory 6 Mattress
- Layflat lumbar support, with the mattress built into the frame
- Flat-Pac hinge system
- Oversized, reinforced tubular frame
- Oversized, oval legs
- Full, high-tensile aluminium frame
- Spring-Loc leg system
- Easy slide, anti-sag zips
- SolarCam camo pattern
- Pac-Away compression straps and carry handle
- Dimensions: 208 x 90 x 40-52cm
- Weight: 14.9kg

SP 3D Dura-Dore Bedchair

- 3D Dura-Dore Mattress
- Layflat lumbar support, with the mattress built into the frame
- Flat-Pac hinge system
- Oversized, reinforced tubular frame
- Oversized, oval legs
- Full, high-tensile aluminium frame
- Spring-Loc leg system
- Layflat lumbar support
- Pac-Away compression straps and carry handle
- Dimensions: 208 x 90 x 40-52cm
- Weight: 10.1kg



**SP C-Tech Waterproof
Bedchair Shroud and
SP C-Tech Waterproof
Bedchair Shroud -
Wide (Both Fit SP & SP
C-Tech Beds**

- 20k waterproof material with taped seams
- Fitting to SP and SP C-Tech Beds via toggles
- Storm pole attachment by 2 supplied bolts (storm pole not supplied)
- Solar Cam Pattern
- Perfect for use as an ultra lightweight cover in hotter temperatures or as a mosquito protection cover
- Dimensions: 288 x 106cm
- Weight: 0.56kg



3.0

SOLAR 2024
LUGGAGE & ACCESSORIES

Luggage & Accessories



UnderCover Camo Ruckbag

- 600D, PVC backed camouflage fabric
- Reinforced, PVC base
- Twin zip pullers on all pockets for easy access
- Six internal pockets
- Stiffened and padded sides
- Twin carry straps
- Adjustable, neoprene padded shoulder strap and chest strap
- Four external pockets, one full-length pocket for taking buzzer bars etc.
- External bankstick straps
- Dimensions: 55 x 45 x 24cm
- Weight: 2kg

UnderCover Camo Bedchair Bag

- UnderCover Camo Bedchair Bag
- Great protection for your Solar, or other, bedchair
- UnderCover Camo pattern
- 600D PVC backed material
- Full zip on 3 sides for easy opening/loading/unloading
- Compression clips so that the bag size can be adjusted to suit various bedchairs
- Compatible with Solar standard and wide bedchairs and sleep systems
- Adjustable shoulder strap
- Dimensions: 91 x 38 x 84cm
- Weight: 1.88kg





UnderCover Camo Carryall - Medium

- 600D, PVC backed camouflage fabric
- Easy access, easy to load storage
- Large external zipped pocket on the front with twin zips for easy access
- Twin carry handles
- Reinforced, hard-wearing, PVC base
- Adjustable shoulder strap
- Lined and padded
- Dimensions: 60 x 30 x 27cm
- Weight: 1.22kg

UnderCover Camo Carryall - Large

- 600D, PVC backed camouflage fabric
- Easy access, easy to load large-scale storage
- Large external zipped pocket on either end with twin zips for easy access
- Twin carry handles
- Reinforced, hard-wearing, PVC base
- Adjustable shoulder strap
- Lined and padded
- Dimensions: 70 x 42 x 27cm
- Weight: 1.62kg



South Westerly Pro Camo Cool Bag

- Insulated and reflective lining that can be wiped clean
- Our 600D, UnderCover Camo outer fabric
- Reinforced base
- Internal, zipped pocket in the lid
- Carry handles and adjustable, padded shoulder strap
- Dual-zipped main compartment
- Large, dual-zipped front pocket for storing gas canisters, utensils or cooking equipment
- Dimensions: 35 x 29 x 24cm
- Weight: 1.11kg





UnderCover Camo Scales Pouch

- Padded, zipped storage pouch for your weigh scales
- Ultra hard-wearing, PU-backed, waterproof material
- Zipped access and a zipped, rubberised-mesh pocket
- Dimensions: 21 x 5.5 x 28cm
- Weight: 0.3kg



UnderCover Camo Accessory Pouch (Tiny, Small, Medium and Large)

- The perfect storage solution for smaller items
- UnderCover Camo pattern
- 600D, PVC backed material
- Double zips for easy access
- Carry handle
- 4 sizes available
- Dimensions: 8 x 11 x 7cm, 18 x 13 x 6.5cm, 18 x 13 x 10 & 18 x 25 x 10cm
- Weight: 0.15kg, 0.27kg, 0.22kg & 0.35kg



UnderCover Camo Multi-Pouch - Compact

- By popular demand
- Made from 600D UnderCover Camo material
- 14 inner pockets
- Snap-Loc magnetic internal divider
- Stiffened sides
- Hard lid with raised sides designed as a lap-top rig table
- Carry handle
- Double zips for easy access
- Dimensions: 27 x 12 x 19cm
- Weight: 0.8kg

UnderCover Camo Multi-Pouch - Large

- Made from 600D UnderCover Camo material
- 14 inner pockets
- Snap-Loc magnetic internal divider
- Stiffened sides
- Hard lid with raised sides designed as a lap-top rig table and also moulded so it can be used as a tablet stand (great for video watching in the bivvy)
- Carry handle
- Double zips for easy access
- Dimensions: 30 x 22 x 14cm
- Weight: 1kg

UnderCover Camo 3+2 Rod Holdall

- Based on the hugely popular SP 3+2 Holdall
- 600D, PVC backed, camouflage fabric
- All-round padding
- Internal padded dividers
- Takes 3 made-up rods internally and 2 rods/sleeves externally
- Padded, adjustable shoulder strap
- Two external, zipped pockets with reinforced bases for storage of banksticks etc
- Dimensions: 170 x 31 x 28cm, 195 x 31 x 28cm & 215 x 31 x 28cm
- Weight: 1.68kg, 1.78kg & 1.85kg



UnderCover Camo Single Rod Sleeves

- Fully padded internally
- 600D, PVC backed, camouflage fabric
- Profiled to take 50mm butt rings (1.2ft and 1.3ft only)
- Reinforced base to protect tip rings
- Double zips for easy opening
- Rotating clip for secure fastening to a quiver or SP 3+2 rod sleeve
- Dimensions: 170 x 26cm, 200 x 26cm & 215 x 26cm
- Weight: 0.5kg, 0.8kg & 0.58kg



New!



SP C-Tech Tackle Carryall System

- Solar System Modular Concept
- Leading tackle box compatible pockets
- Removable, self-ventilating AirStrap
- Waterproof, EVA Foundation
- Vertabr8 rigid body
- Dimensions: 60 x 35 x 28cm
- Weight: 2.46kg

SP C-Tech Barrow Bag XL

- Solar System Modular Concept
- Tackle box compatible pockets
- Removable, self-ventilating AirStrap
- Waterproof, EVA Foundation
- Internal dividers
- Vertabr8 rigid body
- Dimensions: 70 x 44 x 28kg
- Weight: 3.32kg

New!



New!

SP C-Tech Large Rucksack

- Solarspension Harness Shock absorbing straps for optimum comfort
- Quick access tackle box top pocket
- Ergonomic, self-ventilating AirStrap Harness
- Extensive lumbar padding
- Waterproof, EVA Foundation
- 6 x External bankstick/ alarm loops
- Vertabr8 rigid body
- Dimensions: 45 x 30 x 50cm
- Weight: 2.09kg

New!

SP C-Tech Rig Station

- Built in rig tray in the lid
- Internal organised storage of terminal packet, boxes and tools
- Dimensions: 24 x 21 x 11cm
- Weight: 1.11kg



New!



SP C-Tech Compact Buzzer Bar Bag

- Accommodates compact 2 rod and snug 3 rod buzz bars
- Internal receiver pocket
- Adjustable buzzer bar connection loops
- Outer Bankstick storage loops
- Extra heavy padding
- Internal indicator pocket
- Internal leg pocket
- World Wide compatible main bar bag supplied
- Dimensions: 29 x 17 x 7cm
- Weight: 0.45kg

SP C-Tech Buzzer Bar Bag

- Accommodates standard and wide 3 rod buzz bars
- Internal receiver pocket
- Titanium Arm storage loops
- Adjustable buzzer bar connection loops
- Outer Bankstick storage loops
- Extra heavy padding
- Internal indicator pocket
- Internal leg pocket
- World Wide compatible Main bar bag supplied
- Dimensions: 46 x 24 x 8cm
- Weight: 0.9kg



New!



New!



SP C-Tech SubTemp 25LTR Cool Bag

- Removable, self-ventilating AirStrap
- EVA Water resist base
- Heavy thermal lining – keeps contents cool
- Pull out wipe clean PVC lining
- Main Dinnerware organized pocket (cutlery and plates not supplied)
- 2 x Side pocket
- 2 x Accessory front pockets
- Vertabr8 rigid body
- Dimensions: 46 x 32 x 35cm
- Weight: 2.02kg

SP C-Tech SubTemp 15LTR Cool Bag

- Removable, self-ventilating AirStrap
- EVA Water resist base
- Heavy thermal lining – keeps contents cool
- Pull out wipe clean PVC lining
- Main Dinnerware organized pocket (cutlery and plates not supplied)
- 2 x Side pocket
- 2 x Accessory front pockets
- Vertabr8 rigid body
- Dimensions: 49 x 23 x 23cm
- Weight: 1.76kg

New!

SP C-Tech Travel Bag

- Self-ventilating AirStrap
- Boot Pocket with wipe clean material
- Toiletry compartment
- Dirty and clean membrane (keep your clean/dirty clothes always separate)
- Dimensions: 66 x 32 x 23cm
- Weight: 1.59kg





SP C-Tech Large Tech Case

- EVA molded protective body
- 2 x USB connectors (to connect devices to battery pack inside)
- Configuration dividers
- Internal tablet protection sleeve
- Clear lead pocket
- Rigid Body
- Dimensions: 46 x 25 x 12cm
- Weight: 1.52kg

New!



SP C-Tech Mini Tech Case

- Convenient storage of overnight electricals ie headtorch, Bivvy Light etc
- Dimensions: 21 x 6 x 8cm
- Weight: 0.11kg

New!



New!

SP C-Tech Camera Bag

- Solar System Modular Concept
- Removable, self-ventilating AirStrap
- Heavy protective padded lining (Hold DSLR camera body with lens)
- Accessory pocket built into the base for spare batteries, cards and shutter remotes
- Magnetic Snap-Loc removable side pouch for additional lens or flash gun
- Dimensions:
- Main compartment: 13 x 12 x 26cm
- Side compartment: 12 x 6 x 26cm
- Weight: 0.6kg



New!

SP C-Tech Magnetic Tool Case

- Magnetic strip connector for attaching to bivvy walls
- Elastic loops for tools and terminal tackle
- Dimensions: 21 x 7 x 8cm
- Weight: 0.29kg





New!

SP C-Tech Accessory Case Large

- Solar System Modular Concept
- Vertabr8 rigid body
- Wipe Clean Lining
- Dimensions: 25 x 22 x 10cm
- Weight: 0.35kg



New!

SP C-Tech Accessory Case Medium

- Solar System Modular Concept
- Vertabr8 rigid body
- Wipe Clean Lining
- Dimensions: 22 x 13 x 10cm
- Weight: 0.35kg

**SP C-Tech Wash Bag**

- Solar System Modular Concept
- Fold out hanging design with hook
- Built in mirror
- Clear removable pocket for toothbrush and toothpaste
- Internal mesh pocket for smaller items
- Additional storage space for toiletries and toilet roll
- Dimensions: 22 x 12 x 18cm
- Weight: 0.43kg

**New!****SP C-Tech Scales Pouch**

- Solar System Modular Concept
- Heavy padding to protect scales
- Waterproof cover to protect scales from the elements when left by the unhooking mat
- Back pocket for weigh bar storage
- Dimensions: 22 x 7 x 25cm
- Weight: 0.44kg

**New!****SP C-Tech Brewkit Case**

- Foil lined thermal milk storage compartment
- Gas cannister compartment (can be stored inside the bag when in use)
- Cup compartment
- Spoon loop storage
- Dimensions: 22 x 13 x 29cm
- Weight: 0.69kg



New!

SP C-Tech 3 Rod Holdalls (10ft, 12ft & 13ft)

- Solar System Modular Concept
- Self-ventilating AirStrap attachment hooks (for multiple connection of sleeves to one strap)
- Individual Rod and reel compartments for ultimate protection
- Designed for 50mm guides
- Lead Pocket
- Expansion joints for spacious reel storage
- Anti snag internal lining
- Zip up from spine, eliminating chance of catching reel line in the zip
- Dimensions: 169 x 27 x 42cm, 199 x 29 x 45cm, 211 x 43.5 x 27.5cm
- Weight: 2.22kg, 2.32kg & 2.52kg

SP C-Tech Single Rod Sleeves (10ft, 12ft & 13ft)

- Solar System Modular Concept
- Self-ventilating AirStrap attachment hooks (for multiple connection of sleeves to one strap) Strap not supplied
- Tip first zip up for simple insertion of rod and reel
- Anti snag internal lining
- Dimensions: 167 x 30cm, 196 x 30cm, 209 x 30cm
- Weight: 0.66kg, 0.7kg & 0.72kg

New!





New!

SP C-Tech Deluxe Stink Bag (For Nets, Slings, Storm Poles etc)

- Self-ventilating AirStrap attachment hooks (for multiple connection of sleeves to one strap)
Strap not supplied
- Welded PVC waterproof body
- Designed to fit 2 x slings and nets
- 6 x External stormpole/bankstick pockets/loops
- Dimensions: 148 x 20 x 6cm
- Weight: 0.76kg

SP Rod Wraps

- A pair of neoprene-backed, Velcro rod wraps; one wide for your rod butts and a thinner wrap for the rod tips
- Black, with a rubberised Solar logo
- Dimensions: 22 x 8cm & 13 x 5cm
- Weight: 0.03



UnderCover Camo Traveller Rod Sleeve Strap

- A pair of neoprene-backed, Velcro rod wraps; one wide for your rod butts and a thinner wrap for the rod tips
- Black, with a rubberised Solar logo
- Dimensions: 120cm
- Weight: 0.15kg



SP Neoprene Gas Canister Cover

- Self-ventilating AirStrap attachment hooks (for multiple connection of sleeves to one strap)
Strap not supplied
- Welded PVC waterproof body
- Designed to fit 2 x slings and nets
- 6 x External stompole/bankstick pockets/loops
- Dimensions: 11 x 1cm
- Weight: 0.06kg



New!

SP C-Tech Bankstick Roll

- Neat roll-up storage of 3 rod bankstick setups
- Magnetic closure
- Designed to accommodate 12 & 16" banksticks, complete with alarms, indicators and backrests
- Dimensions: 63.5 x 59cm
- Weight: 0.56kg



New!

Solar Slimline Pillow

- Comfortable heavy Hollow fill internal padding
- Toggles for secure connection of Solar SP and SP C-Tech MK11 beds
- Adjustable webbing strap for secure fitting of all types of bedchair
- Fleece side for winter comfort
- Cotton side for summer comfort
- Slimline version suits taller anglers that want extra leg space
- Dimensions: 70 x 30cm
- Weight: 1.14kg

Solar Universal Pillow XL

- Comfortable heavy Hollow fill internal padding
- Toggles for secure connection of Solar SP and SP C-Tech MK11 beds
- Adjustable webbing strap for secure fitting of all types of bedchair
- Fleece side for winter comfort
- Cotton side for summer comfort
- Dimensions: 70 x 48cm
- Weight: 1.14kg



SP C-Tech Bite Alarm Cover

- Fits most bite alarms
- Draw cord bottom
- Indicator storage pocket
- Tall design so can be fitted over Solar Snag ears
- Dimensions: 6 x 5 x 14cm
- Weight: 0.04kg

New!



SP C-Tech Tip & Butt Protector

- Elasticated strap designed to fit 1.2ft and 1.3ft 2pc rods
- Oversized cups to fit any rod diameter
- Dimensions: 6 x 8 cm, 6 x 18cm
- Weight: 0.1kg

A1 Folding Aluminium Table

- Strong, but lightweight aluminium construction
- Removable, folding table top for easy storage and transport
- Independently adjustable legs for levelling in most swims
- Anodised black finish
- Supplied with a free carry case
- Cross bracing on legs for stability
- Dimensions: 51 x 9 x 44cm
- Weight: 4kg



Prodding Stick Kit

- The perfect prodding stick to gauge and investigate the bottom
- Supplied with 4 parts of 1.22 meters/ 4ft
- Contains 3 screw-on tips
- Equipped with various depth markings (in ft and cm)
- Equipped with a large floating handle
- Supplied in a Solar Bag
- Dimensions: 125 x 8 x 8cm
- Weight: 2.02kg



4.0

SOLAR 2024
FISHCARE

Fishcare



Weight/Retainer Sling & Weigh/Retainer Sling Large

- Quick-drain mesh sections in the bottom
- Full-length floatation tubes with reflective strips
- Double zips with securing clip
- Reflective cord neatly housed in a zipped pocket on the sling
- Supplied with storage bag
- Dimensions: 108 x 53 x 25cm & 130 x 53 x 25cm
- Weight: 1.2kg & 1.45kg

Net/Retainer Storage Sleeve

- Eliminates smell and drips from wet nets
- Waterproof storage for your wet nets and slings
- Roll-down/clip fastening allows the length to be suited to 42 and 50" nets and both standard and large retainers/slings
- Welded, PVC material
- Dimensions: 150 x 25cm
- Weight: 0.43kg



UnderCover Weigh/Retainer Sling

- Quick-drain mesh sections in the bottom
- Full-length floatation tubes with reflective strips
- Double zips with securing clip
- Reflective cord neatly housed in a zipped pocket on the sling
- Supplied with storage bag
- Dimensions: 108 x 53 x 25cm & 120 x 53 x 25cm
- Weight: 1.3kg & 1.56kg



Inflation Unhooking Mat

- *Carp safety at its finest*
- *High inflatable walls*
- *Separate inflatable mattress*
- *Ultra durable*
- *Carry handles and Velcro fish cover*
- *Complete with pump and carry case*
- *Dimensions: 120 x 72 x 27cm*
- *Weight: 6.78kg*

Rapid Unhooking Mat

- *Perfect for the mobile angler*
- *Compact design*
- *'Pop-up' design*
- *Ultra-safe 'cot' design*
- *Cover/kneeling mat*
- *Zippered carry bag*
- *Dimensions: 110 x 52 x 29cm*
- *Weight: 2.72kg*





UnderCover Inflatable Unhooking Mat

- Based on the SP Inflatable Mat, only slightly larger
- Carp safety at its finest
- High inflatable walls
- Separate inflatable mattress
- Ultra durable
- Carry handles and Velcro fish cover
- Complete with pump and carry case
- Dimensions: 130 x 88 x 28cm
- Weight: 7.94kg

UnderCover Foldable Unhooking Mat

- Oversized cover in our UnderCover Camo Pattern with Velcro fastenings on all sides
- Reinforced, waterproof base
- Profiled, high-density foam inner for excellent protection and with an outer lip to prevent fish from sliding off the mat
- Twin carry handles
- Folds in half and is secured with a quality clip for easy transport and storage
- Pegging point in each corner
- Dimensions: 120 x 70 x 10cm
- Weight: 2.48kg





A1 Weight Tri-Pod

- For steady, accurate weighing of fish
- Heavy gauge aluminium frame
- Adjustable height - from 100cm to 180cm
- Heavy-duty weigh hook, to accept all popular scales
- Rated to 200lb+
- Threaded main block for a camera or buzz bar
- Dimensions: 120cm
- Weight: 2.53kg



Collapsible Water Bucket

- Perfect for wetting fish, mats and balancing pop-ups
- 10 litre capacity
- Easy to store
- Complete with cord and float
- Welded PVC construction for strength and longevity
- Dimensions: 25 x 25cm
- Weight: 0.22kg



Landing Nets

P1 Bow-Loc Landing Net

- One-touch, quick-release Stainless Steel spreader block
- 2 section, 4 + 3' handle
- Matt finish 3k Carbon weave handle
- Japanese shrinkwrap handle for surefast grip
- Ultralight, the Bow-Loc weighs just 800g
- Stainless trim
- 42" super-stiff carbon arms with Stainless collars
- Soft, deep, double stitched olive mesh
- Reinforced Stainless Steel cord ferrules
- Durable, reinforced nylon cord
- Laser etched butt cap
- Supplied in a waterproof, PVC storage/stink bag with welded seams
- Widely acknowledged as the best net you can buy
- Arm Dimensions: 107cm
- Weight: 1.29kg

Why breakdown is so quick:



1 Reduce tension on arms with forearm as shown



2 Press P1 Button to release arms



3 Collapse arms and remove

A1 Bow-Loc Landing Net

- *One-touch, quick-release spreader block made from nylon and Stainless Steel*
- *2-piece, 6ft handle with a spigot joint made from 3k carbon-fibre*
- *3k super-stiff, carbon-fibre arms with profiled, Stainless Steel reinforcement*
- *Shrink-wrap grips for secure grip in all conditions*
- *42" soft, deep, camouflage mesh with double stitching*
- *Profiled ferrules on the arms prevent damage to the mesh*
- *Laser etched butt cap*
- *Supplied in a waterproof, PVC storage/stink bag with welded seams*
- *Arm Dimensions: 107cm*
- *Weight: 1.24kg*



03 30 00 74
92 20 20 20
LUNING NETS

Solar Bow-Lite Landing Net

- *Micro, Stainless Steel spreader block*
- *2-piece, 6ft handle with a spigot joint made from carbon-fibre*
- *Carbon-fibre arms with profiled, Stainless Steel reinforcement*
- *Shrink-wrap grips for secure grip in all conditions*
- *42" soft, deep, camouflage mesh with double stitching*
- *Profiled ferrules on the arms prevent damage to the mesh*
- *Laser etched butt cap*
- *Supplied in a waterproof, PVC storage/stink bag with welded seams*
- *Arm Dimensions: 107cm*
- *Weight: 1.22kg*



Camo Replacement Mesh

- Covert Camo finish
- Fits any 42" landing net arms
- Double stitched for strength
- Soft, fish friendly, quick drying mesh
- Dimensions: 107 x 107cm
- Weight: 0.22kg



Bow-Loc Replacement Mesh

- Fits any 42" landing net arms
- Double stitched for strength
- Soft, fish friendly, quick drying mesh
- Weight: 0.4kg



Bow-Loc Net Float

- Fits most landing net handles/blocks
- Ultra buoyant
- No tangle-prone cord ties
- Dimensions: 6 x 18cm
- Weight: 0.03kg

Hotspot Heat



Hotspot Heat Cushion

- The ultimate in bankside comfort
- Self-heating cushion, which can also be used like a hot water bottle or put under your jacket
- The first heated cushion in angling
- Quick to heat up and long-lasting heat
- Works with any power source with a USB fitting (such as a power pack).
- Camo pattern fabric
- 3 heat settings which will achieve, 30°C / 40°C / 50°C.
- Supplied with a storage / carry bag
- Storage pocket for the cable when not plugged in
- Dimensions: 36.5 x 34.5 x 3cm
- Weight: 0.38kg

Solar Barrows



South Westerly Pro Barrow

- *Extra large loading surface*
- *Folding front and side bars*
- *Extra large, deep storage drop lock barrow bag*
- *Twin mesh pannier bags*
- *Quick release SpringLock pneumatic wheel*
- *EVA comfort quick SpringLock release handles*
- *Set back wheel position for increased height*
- *BalanceSwiveling mud feet*
- *Super durable high tensile steel frame*
- *Compact storage design for boot fitting of small cars*
- *Dimensions: 142 x 78 x 83cm*
- *Weight: 17.14kg*



8.0

SOLAR 2024
P1 STAINLESS BANKWARE

P1 Stainless Bankware



Order on the Trade Website...
www.solartackletrade.com



P1 Universal Pod

- The ultimate in versatility, function and looks
- The Universal takes the key features from all Solar pods and pushes the boundaries further
- Precision engineered and manufactured in the UK
- Dual extendable main bars for stability. Main bar extends from 560mm to 950mm
- Solar's unique ratchet system leg adjustment for individual leg adjustment
- Each leg-adjustment bridge is movable and can be fixed at any point along the main bars
- Drop-down uprights, allowing the pod to pack down flat. 160mm high back uprights and 100mm high front uprights
- Lock-down anchor points on the front and back bridge sections
- 9" adjustable legs with captive thumb screws and new Ground-Probe points
- Weight: 4.4kg

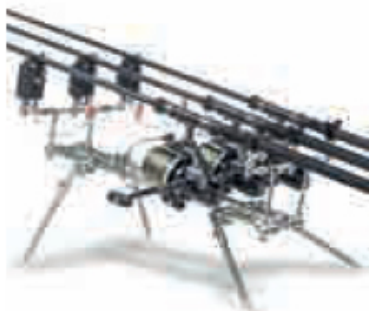

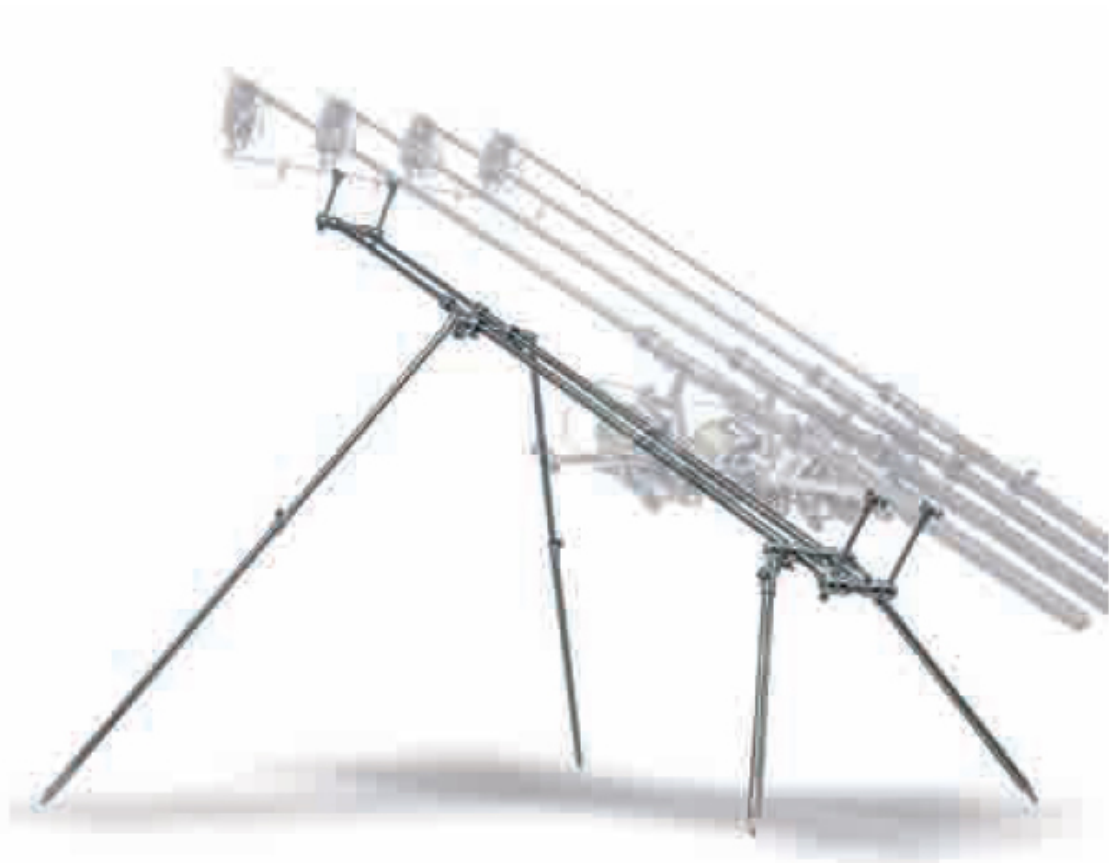

P1 Euro Universal Pod

- The ultimate in versatility, function and looks
- The Universal takes the key features from all Solar pods and pushes the boundaries further
- Precision engineered and manufactured in the UK
- Dual extendable main bars for stability. The main bar is 160mm.
- Solar's unique ratchet system leg adjustment for individual leg adjustment
- Each leg-adjustment bridge is movable and can be fixed at any point along the main bars
- Lock-down anchor points on the front and back bridge sections
- Drop-down uprights, allowing the pod to pack down flat. 160mm high back uprights and 100mm high front uprights
- 16" and 24" adjustable legs with captive thumb screws and new Ground-Probe points.
- The Euro's legs are made from thicker diameter stainless for more strength and stability
- Weight: 6.3kg





P1 Worldwide Pod

- Comprises two upright bridge sections, 4 x 9" legs and a centre bar
- Compact design
- Perfect for ALL terrains
- Highly adaptable
- Micro adjustable in all directions
- Goalpost chassis for total stability
- Made in England
- Complete with carry case



P1 Worldwide Pod (Includes 3-Rod Fixed Buzz Bar)

- Comprises two upright bridge sections, 4 x 9" legs and a centre bar
- Compact design
- Perfect for ALL terrains
- Highly adaptable
- Micro adjustable in all directions
- Goalpost chassis for total stability
- Made in England
- Complete with carry case





P1 Mini Worldwide Pod

- Solar's World renowned Worldwide Pod in a mini version
- Precision engineered and manufactured in the UK
- Solar's unique ratchet leg adjustment system
- Sold with 4 x P1 stubby legs
- The uprights are tight together, so will fit all Solar buzzer uprights that are 50mm apart
- Front uprights are 85mm high to accommodate alarms. Rear uprights are 130mm high
- Complete with compact, adjustable main bar, which extends from 400mm to 690mm
- Supplied in an SP-style, Solar Worldwide Pod bag
- Weight: 1.8kg



P1 Stubby Pod Legs (pair)

- Ultra-short, 3" (7.6cm) Stubby Legs fit straight onto any Worldwide Pod in place of the 'standard' legs
- For a low-profile set up or to increase the angle at which the pod sits
- Plus, they make the assembly look stunning
- Two non-adjustable legs per pack
- Compatible with all Solar Worldwide Pods



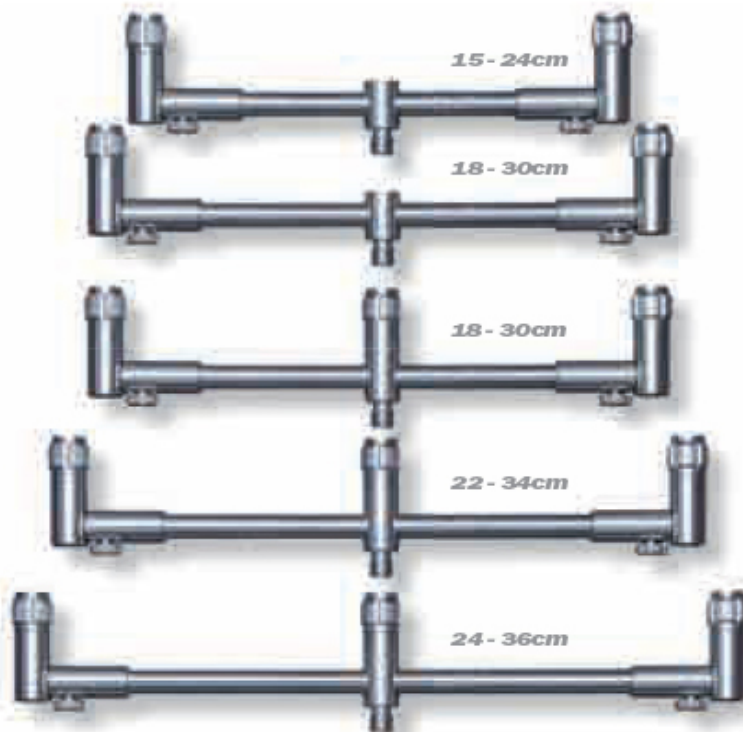

P1 Pro-Loc 2 and 3-Rod Adjustable Buzzer Bars

- Precision engineered, designed and manufactured in the UK
- Captive stainless thumb screw width adjustment
- 3/8" BSF thread, compatible with all Solar banksticks and most others
- Sure-fit, 5-spoke knurled locking collars for perfect alignment of alarms and back rests
- Engraved Solar logo
- Flat underside profile on the inner sections so that the bars can't twist/wobble when extended
- Weight: From 0.18kg



P1 Centre-Loc Adjustable Back Rest Standard and Mini

- Precision engineered in the UK
- Made from high-grade Stainless Steel with anti-slip, rubberised arms
- Quick and easy width adjustment to perfectly suit all rod butts
- P1 5-spoke knurling
- High-grade Stainless Steel
- Designed with 3/8 BSF thread to fit with most banksticks
- Dimensions: 4 x 2.5cm & 2.5 x 2cm



P1 Loc-Down Adaptor and Buzzer Bar Blanking Cap

- Protects male and female buzzer bar threads when not in use
- Designed with 3/8 BSF thread to fit with most alarms, back rests etc

P1 Snap-Loc Kit-Off Adaptor

- Enables swift assembly and disassembly of buzzer bar and bankstick set-ups
- Precision engineered in the UK
- Sure-fit, 5-spoke knurled locking collars for perfect alignment of alarms and back rests
- Designed with 3/8 BSF thread to fit with most alarms, back rests etc

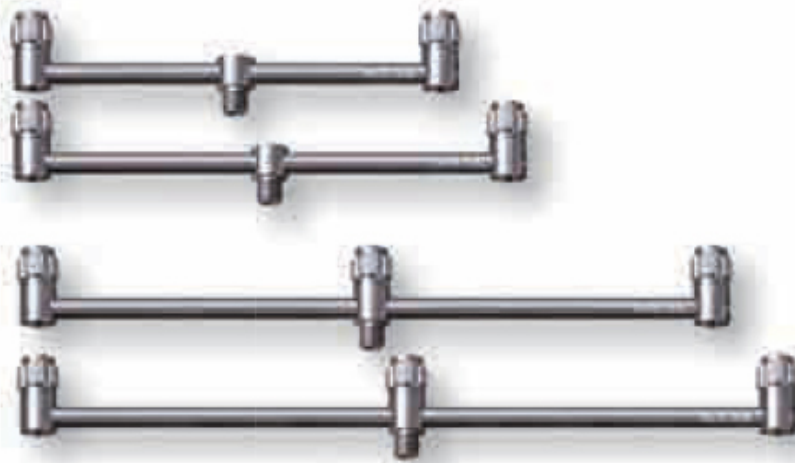

P1 2 and 3-Rod Fixed Buzzer Bars

- Precision engineered in the UK
- Machined solid Stainless Steel bar
- Sure-fit, 5-spoke knurled locking collars for perfect alignment of alarms and back rests
- Designed with 3/8 BSF thread to fit with most banksticks
- High-grade Stainless Steel
- Iconic design
- Lightweight
- Will last a lifetime
- Rock solid set-up

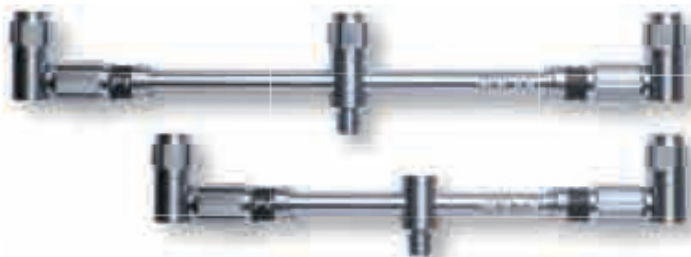

P1 2 and 3-Rod Adjustable Buzzer Bars

- Iconic design
- Precision engineered in the UK
- Profiled extension bar to eliminate twist
- Machined solid Stainless Steel bar
- Sure-fit, 5-spoke knurled locking collars for perfect alignment of alarms and back rests
- Designed with 3/8 BSF thread to fit with most banksticks
- Will last a lifetime
- Rock solid set-up
- Solar Taper-loc™ adjustment
- Carbon detailing
- Will not tip



Pro-Loc Anti-Twist Banksticks

- Eliminates buzzer bar twist
- The first of its kind
- Precision engineered in the UK
- Profiled insert to eliminate twist
- Ground Driver point for hard ground twist
- Quick and easy height adjustment via the 5-spoke knurled collar
- High-grade Stainless Steel
- Weight: 0.2kg onwards





P1 Travellite Bankstick

- The 'industry standard'
- Precision engineered in the UK
- Compatible with all common back rests, bite alarms etc
- Ground Driver point for hard ground twist
- Quick and easy height adjustment via the 5-spoke knurled collar
- Lightweight
- High-grade Stainless Steel
- Weight: 0.12kg onwards



P1 Bankstick Stabiliser

- For a rock solid, no twist set up
- Adjustable Stainless Steel pin for any ground
- P1 detailing
- Precision engineered in the UK
- Built for reliability and a lifetime of use, like all Solar products





Drop-In Goalpost Converters

- Converts any buzz bar to a goalpost set up
- Sprung thread to eliminate loss
- Precision engineered in the UK
- Built for reliability and a lifetime of use, like all Solar products
- Sold in pairs



P1 Stage Stand - 1x Large Upright

- Precision engineered in the UK
- Profiled insert so that it cannot twist
- Our unique, drop-in buzz bar attachment for secure fit and no twist
- P1 Stainless Steel screwdriver included
- 3 sizes of wood screws included
- High-grade Stainless Steel



P1 Weight Lifter Weight Bar

- The strongest on the market
- Dual function for hand held or landing net handle mounting
- Delivers a lifetime of trouble-free, safe, accurate weighing
- Precision made in the UK from premium grade Stainless Steel
- Sturdy carabiner supplied



P1 Adjustable Snag Bar

- Fully height adjustable bars allow for one, both (or neither) rod retaining arms to be in use, covering every possible fishing situation
- 'T' Slotted adjustable base plate to accommodate ANY bite alarm
- 2BA thread to take all common chains, arms and Solar Titanium indicators
- Stainless Steel construction throughout
- CAD designed
- 'Hex' key supplied
- Made in England
- Built for reliability and a lifetime of use, like all Solar products

9.0

SOLAR 2024
BLACKLITE BANKWARE

BlackLite Bankare



BlackLite Worldwide Pod

- Solar's World renowned Worldwide Pod in a lightweight alloy version
- Precision engineered
- Solar's unique ratchet leg adjustment system
- Sold with 4 x 6-inch adjustable legs and its all standard 3/8 BSF threads to add longer banksticks to extend further
- The uprights are tight together, so will fit all 3-rod Solar buzzer bars and the larger 2-rod adjustable buzzer bars
- Front uprights are 85mm high to accommodate alarms. Rear uprights are 130mm high
- Complete with compact, adjustable main bar, which extends from 400mm to 690mm
- Supplied in an SP-style, Solar Worldwide Pod Bag
- Weight: 1.51kg

- Complete with a pair of Blacklite Pro-Loc 3-Rod Adjustable Buzzer Bars (Pro-Loc Thumb Screws)
- Made from high-grade aluminium with a hard-anodised, black finish
- Sure-fit, 5-spoke knurled locking collars for perfect alignment of alarms etc
- 3/8" BSF thread, compatible with all Solar bankware and most others... alarms too



New!



Order on the Trade Website...
www.solartackletrade.com

BWMS & SHEETERS
BEHARRIS
SLEEP SYSTEMS
& CHAIRS
LUGGAGE &
ACCESSORIES
FISHING
LANDING NETS
HOT SOFTHEAT
SOLAR
BANKWARE
P1 SWINNESS
BANKWARE
BLACKLITE
BANKWARE
AL ALUMINIUM
BANKWARE
SOLAR SYSTEM BITE
INDICATION
SOLAR
MANUJINES
HOOKS & RIG TOOLS
THE SMALL
PRINT



BlackLite Aluminium Banksticks

- An entirely-new range of high-end Solar Tackle bankware
- Precision engineered, designed and manufactured in the UK
- Made from high-grade aluminium with a hard-anodised, black finish
- Captive stainless thumb screw height adjustment
- 3/8" BSF thread, compatible with all Solar bankware and most others... alarms too
- Lightweight, carbon inner
- Engraved Solar logo
- Features Solar's new Ground Probe, engineered point
- Available in 4 lengths, all of which are adjustable: 9", 12", 16" and 20"
- Weight: From 0.11kg



BlackLite Kit-Off Adaptor

- Enables swift assembly and disassembly of buzzer bar and bankstick set-ups

Made from high-grade aluminium with a hard-anodised, black finish

- Designed with 3/8 BSF thread to fit with most alarms, back rests etc



BlackLite Bankstick Stabiliser

- Precision engineered, designed and manufactured in the UK
- Made from high-grade aluminium with a hard-anodised, black finish
- Captive stainless thumb screw for adjusting the ground pin height
- Stainless steel ground pin (90mm long)
- 1.3mm diameter hole, so fits all Solar banksticks, and many others too
- Engraved Solar logo
- Weight: 0.06kg



BlackLite Aluminium Adjustable Buzzer Bars

- Precision engineered, designed and manufactured in the UK
- Made from high-grade aluminium with a hard-anodised, black finish
- Captive stainless thumb screw height adjustment
- Sure-fit, 5-spoke knurled locking collars for perfect alignment of alarms etc
- 3/8" BSF thread, compatible with all Solar bankware and most others... alarms too
- Lightweight, carbon inner
- Engraved Solar logo



BlackLite Centre-Loc Adjustable Back Rest Standard and Mini

- Based on our in-demand Centre-Loc Back Rests
- Precision engineered in the UK
- Made from high-grade aluminium with anti-slip, rubberised arms
- Quick and easy width adjustment to perfectly suit all rod butts
- 5-spoke knurling
- High-grade Stainless Steel
- Designed with 3/8 BSF thread to fit with most banksticks



BlackLite Snag Bars

- Stops rods being dragged out of the alarms when snag fishing or fishing at an acute angle to the set-up
- Made from high-grade aluminium with a hard-anodised, black finish
- Accommodates ANY bite alarm
- 2BA thread to take all common chains, arms and Solar Titanium indicators
- CAD designed
- Built for reliability and a lifetime of use, like all Solar products

A1 Aluminium Bankware



A1 Screw Point Storm Poles

- *Super-light*
- *Premium, black anodised aluminium*
- *Machined screw points*
- *Perfect for ultra-high Continental set-ups*
- *Easy to adjust via Cam-Loc system*
- *Solar build quality*



Solar System Bite Indication



Titanium Indicator Arm Short and Long (Indicator Head not included)

Covers ALL indication options from slack lines to tight lines at mega distance

- Incredibly durable aerospace grade materials
- Solar DNA
- Precision made
- P1 stainless collar
- Comes with Titanium Arm, hockey stick, Grip Clip plus 12 & 14mm StrongArm Line Clips
- Compatible with our Titanium Heads (right) and all 2BA Indicator heads



TITANIUM INDICATOR HEADS AVAILABLE SEPARATELY



Titanium Drop Back Weights 15 and 30g

- Compatible with all 2BA Indicator fittings
- Precision made
- P1 Stainless 5-spoke Knurling



Strongarm Line Clip

- The best line clip available
- Simple push fit
- Available in two sizes
- Another Solar classic





Plastic Micro Adjustable Line Clips

- Compatible with 2BA Indicators
- 2 per pack
- Adjustable for mono or braid
- * Not compatible with Titanium Indicator Heads

P1 Stainless Hanga Ball Line Clip

- High-precision, next-generation version of our original Hanga Ball Line Clip
- Friction-free rotation on the uprights for perfect functionality on any set up
- Works perfectly with all lines; monofilament, fluorocarbons and braids
- 2BA thread, compatible with all Solar bite indicator systems past, present and future as well as being compatible with most other indicator systems as well
- The P1 model is made from high-grade stainless steel throughout
- Designed and made in the UK

"When you see the detail, design and engineering in our line clip and consider the same passion and expertise goes in to ever Solar item, you need look nowhere else!"



Grip Clip

- Compatible with all 2BA Indicators
- Detects the slightest line movement
- Perfect for slack line fishing
- * Not compatible with Titanium Indicator Heads



Plastic Hockey Stick

- Compatible with our Titanium Range and all 2BA Indicator fittings
- Precision made



BlackLite Aluminium Hockey Stick and Stainless Steel Hockey Stick

- Precision engineered, designed and manufactured in the UK
- One is made from high-grade aluminium with a hard-anodised, black finish and the other from high grade stainless steel
- Compatible with all our Solar Indicator chains and all 2BA Indicator fittings
- Precision made
- * NOT compatible with Titanium Indicator arms



P1 Stainless Hockey Stick

- Compatible with our Titanium Range and all 2BA Indicator fittings
- Precision made
- P1 Stainless 5-spoke knurling

P1 Hockey Stick Adaptor

- Compatible with our Titanium Range and all 2BA Indicator fittings
- Precision made
- P1 Stainless 5-spoke knurling



Black Stainless Chain

- Compatible with all Solar indicator and 2BA indicators
- A high-grade, Stainless Steel indicator chain with a black finish that features black, plastic fittings at either end
- One chain per pack



Stainless Ended Chain

- Compatible with all Solar indicator and 2BA indicators
- A high-grade, Stainless Steel chain with Stainless Steel fittings at either end
- One chain per pack



Line Biter Indicator

- Detects and exaggerates movements indicators miss!
- Foolproof clip-on mechanism
- Hi-viz orange
- Glow in the dark, reflective banding
- Floating
- Flags your line position when you are navigating your boat



Rubber 'O' Rings

- Replacement 'O' rings for 3/8 BSF threads on alarms, rests etc
- Enable easy fitting alignment
- Provides a secure fit for any alarms, rod rests etc

Lock&Load Indicator Head Kit - Black and PTFE

- Part of the Solar System, enabling you to design the bespoke indication system of your choice.
- Lock&Load Indicator Head Kit complete with:
- 5x 1g Micro Drop Back Weights
- Lock&Load Interchangeable End Caps
- Micro Adjustable Line Clip
- BlackLite Hockey Stick
- BlackLite Stainless 5" Chain
- 15g and 30g Drop Back Weights available
- Isotope sizes available
- Compatible with ALL Solar Line Clips



Lock&Load Indicator Head Kit - Stainless with Hanga Ball Line Clip

- Part of the Solar System, enabling you to design the bespoke indication system of your choice.
- Lock&Load Indicator Head Kit complete with:
- 5x 1g Micro Drop Back Weights
- Lock&Load Interchangeable End Caps
- P1 Stainless Ball Line Clip
- P1 Stainless Hockey Stick
- P1 Stainless 5" Chain
- 15g and 30g Drop Back Weights available
- Isotopes available
- Compatible with ALL Solar Line Clips



New!



Lock&Load Indicator Heads

- Part of the Solar System, enabling you to design the bespoke indication system of your choice.
- Lock&Load Indicator Head complete with:
- 5x 1g Micro Drop Back Weights
- Lock&Load Interchangeable End Caps
- Micro Adjustable Line Clip (for Black and PTFE versions)
- Stainless Hanga Ball Line Clip (for Stainless version)
- 15g and 30g Drop Back Weights available
- Isotopes available
- Compatible with ALL Solar Line Clips

Lock&Load Nite-Glo and Carbon Indicator Heads

- Part of the Solar System, enabling you to design the bespoke indication system of your choice.
- Complete with P1 Stainless Hanga Ball Line Clip
- Made in England, as always
- Drag Weights are available in 15g and 30g
- Includes FREE colour coded locking ring which sits under your alarms or back rests

Lock&Load Indicator End Caps - Set of 2

- Part of the Solar System, enabling you to design the bespoke indication system of your choice.

Solar Mainlines



South Westerly UniLine Mono

- High power universal mainline mono
- Super Strength, durability & abrasion resistance

A reduced diameter, super-high-strength monofilament with a supple feel that doesn't cost the earth. It will cope with the harshest of conditions; through weed or over rough lake beds. The clear finish makes it virtually undetectable to wary fish.

SP C-Tech Mile High Mono

- Ultra Long Range Casting Mainline Monofilament
- Highest Strength, durability & abrasion resistance multi layered construction

The material used in the construction of SP C-Tech Mile High mono is unbelievably strong and offers the highest in diameter-to-breaking-strain ratios with exceptional toughness and durability. Tied with a good technical knot, such as a Palomar, line diameters can be stepped down which delivers the greatest advantage for straight-through, extreme distance fishing. Picking the right diameter to lead size will give you that massive advantage in improved casting distance without the use of leaders.

Our UV Deflect coating provides UV resistance. This prolongs the line's life and reduces wear, meaning strength is not lost over time and knots bed in better, while the Direct Connect Core delivers the lower stretch and high strength this product is known for.



Diameter	0.31mm	0.34mm	0.36mm	0.40mm
Stated B.S.	11lb/5kg	14lb/6.35kg	17lb/7.71lb	20lb/9.07kg
Achievable B.S.	17lb/7.7kg	22lb/10kg	27lb/12.25lb	32lb/14.56kg
Lead Size (no leader)	3.5oz/100g	4oz/115g	5oz/140g	5oz+/140g+



Diameter	0.31mm	0.33mm	0.37mm	0.40mm
Stated B.S.	10lb/4.54kg	12lb/5.45kg	15lb/6.8kg	18lb/8.16kg
Achievable B.S.	16lb/7.25kg	18lb/8.16kg	22lb/10kg	26lb/11.8kg
Lead Size (no leader)	3.5oz/100g	4oz/115g	5oz/140g	5oz+/140g+



Order on the Trade Website...
www.solartackletrade.com



South Westerly BulletProof Mono

- High power mono for use in harsh environments with heavy weed and rocky bars
- Super Durable, extreme abrasion & reliability

Bulletproof is a monofilament developed to be the most reliable there is. The X-Tuff construction makes it best in class when handling the most savage obstacles a lakebed can throw up, from razor sharp, stony bars to mussel-clad weed. Using Bulletproof will boost any angler's confidence when landing fish and will remove that doubt that can be present with other lines.

The Bulletproof construction includes a slick finish that lowers wear and tear and slows UV degradation, while the inner construction increases suppleness and it sinks, fast!



SP Spod & Marker Braid

- Ultra long casting spod & marker braid
- Anti Windknot Coating

Solar Spod & Marker Braid comes in 2 sizes; 20lb super-low diameter for use with a shock leader where anglers want to hit extreme ranges and a 30lb version for hassle-free, direct attachment of baiting and feature-finding devices (no leaders necessary). The Hi-Vis Neon Green finish allows you to follow your line out on the cast for better accuracy and our special, surface coating reduces the chance of wind knots.



Diameter	0.32mm	0.35mm	0.39mm
Stated B.S.	12lb/5.45kg	15lb/6.8kg	18lb/8.16kg
Achievable B.S.	18lb/8.16kg	21lb/9.5kg	28lb/12.7kg
Lead Size (no leader)	3.5oz/100g	4.5oz/130g	5oz+/140g+



Order on the Trade Website...
www.solartackletrade.com

BENCHWARE
 SEED SYSTEMS
 RODS & REELS
 LUGGAGE & ACCESSORIES
 FISHPHARE
 LANDING NETS
 HOT SPOTHEAT
 SOLAR BRIBONS
 P1 STAINLESS BRIBWARE
 BLACKTIE BRIBWARE
 AL ALUMINIUM BRIBWARE
 SOLAR SYSTEM BITE
 SOLAR MAINLINES
 HOOKS & RIG TOOLS
 THE SMALL FISH

Hooks & Rig Tools



Stronghold 101

- The ultimate carp hook!
- Mute Camo finish
- Razor sharp
- Incredibly strong
- Perfect for most rigs
- Adopted by many leading anglers as their 'go to' snag/Continental hook



Stronghold Longshank

- Optimum anti-eject properties
- Mute Camo finish
- Razor sharp
- Incredibly strong

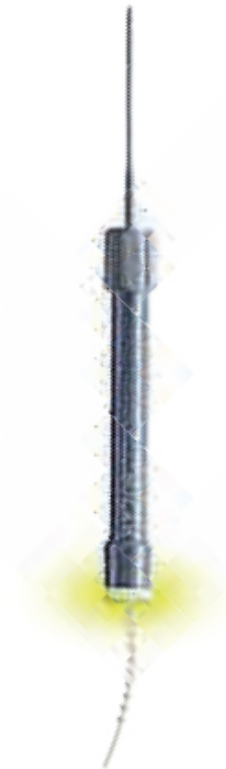

P1 Boilie and Stop Needle

- Strong, Stainless needle with safety barb
- Solar's 5 Spoke, Diamond Grip
- Refillable bait stop dispenser
- Nite-Glo bait stop dispenser for easy location in the dark
- Stainless Steel construction
- CAD designed
- Replaceable needle
- Built for reliability and a lifetime of use, like all Solar products

Serrated Blade Scissors

- Seriously sharp scissors with serrated blades that cut cleanly through all braids, monofilaments and fluorocarbons
- They keep their sharpness for eons
- Large enough to accommodate the biggest hands, yet small enough to fit easily into your tackle box
- Laser-etched Solar logo on the blade
- The bright orange handle makes them easy to find in your tackle box or bivy
- Supplied with a protective, plastic sheath





Rig Cone Tool

- The perfect tool for precision-shaping shrink tube and chod rigs while keeping your fingers safe. Holds hooks of all sizes
- The diameter tapers from 10mm to 35mm, so you can perfectly form anything from tiny lengths of shrink tube right through to Wither and Chod Rigs
- Removable handle, which doubles as a knot testing tool. The only one of its kind available



Hair Gauge Tool

- Ensures you get the perfect hair length every time you tie a rig
- Measures hairs from 10mm to 40mm
- Printed on both sides for ease of use for both right and left-handed anglers



Boilie Needle

- The most versatile available
- Easily penetrates even the hardest baits
- Can be used on baits as small as 10mm without splitting
- Features our boilie-stop dispenser (a Solar first)
- Quick and easy to fit with all of Solar's spare needles and drills
- Easy-grip, contoured handle is available in 2 hi-viz colours and a glow-in-the-dark option



Spare Boilie Needle



Spare Maggot Needle



Spare Nut Drill



Spare Stick Needle



Micro and Small Splicing Needles

- Strong, fine, gate-latch needles for splicing leadcore
- Two thicknesses of needle available, micro and small,
- Both feature an easy-grip handle to make splicing any material easy. Two needles per pack

Boilie Needle Spare Set of Tools

- A boilie needle, a fine maggot needle, a PVA stick/stringer needle and a fine nut drill
- The baiting tool for ANY job!

Boilie Stops

- Refills for the boilie stop dispensers in our Boilie Needles

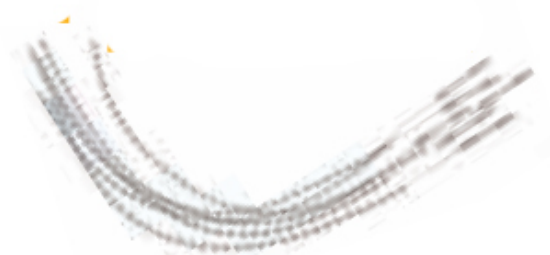

The Small Print

Contact Details

Telephone: +44 (0)1322 277345

Fax: +44 (0)1322 278482

E-mail: sales@solartackle.co.uk

Online: www.solartackletrade.com

Office Hours

Monday to Thursday 8am - 5pm (GMT)

Friday 8am-4pm (GMT)

The office is closed on Saturdays & Sundays

Carriage

Carriage and pricing for delivery remains account specific and agreed with your Solar Account Manager.

Any additional charges incurred by Solar Tackle for carriage raising from issues from the customer's side will be re-charged to the customer. These include but are not limited to refused delivery, driver waiting to unload, delivery re-directed to a different address etc. If any specific delivery instructions are required these MUST be specified when placing an order. This includes, but is not limited to, a requirement for a tail-lift delivery, specific delivery times, specific packing instructions etc. Any carriage, admin and handling charges for returned stock are the responsibility of the customer and not Solar Tackle. These will be re-charged to the customer in the event that Solar Tackle is charged.

Payment Methods

- BACS (call for details. Solar Tackle Limited's bank details are stated on all invoices)
- Credit/Debit Card
- Cheque (addressed to 'Solar Tackle Limited')
- Direct Debit (call or e-mail for details)

**Trade Website**

Solar Tackle has a trade website where you can check product information, images and stock availability and create and place your trade orders 24/7.

If you do not already have an account on our trade website then you can apply online using the link at the bottom of the page at www.solartackletrade.com.

Alternatively, you can e-mail sales@solartackle.co.uk with your shop name and request that an online account be set up for you.

**POS**

Solar Tackle can provide Point Of Sale items to aid the display, promotion and sales of our products in your store.

For these items and any other promotional items or information you require please e-mail sales@solartackle.co.uk or call +44 (0) 1322 277345

Prices

The price(s) are given in good faith to the Retailer and are those ruling at the time of Solar's latest publicised pricing schedule. All prices are subject to market fluctuations and revisions and the actual price(s) to be paid by the Buyer shall be the Seller price ruling at the date of dispatch.

The company does not operate on a sale or return basis.

PLEASE NOTE: Trade packs cannot be split.

Payment

Where credit terms have been agreed, invoices are to be paid in full within 30 days of the date of invoice.

If amounts are paid into the wrong bank account (i.e. not to the account stated on the order invoice), then all incurred fees and charges will be recharged to the customer.

Overdue Accounts

The company reserves the right to take whatever action is deemed necessary within law to recover the outstanding amounts. The Buyer will be responsible for all costs incurred in recovering outstanding, or non, payments. All overdue accounts will incur a 2% cumulative surcharge for each month the amount is unpaid. This action will commence 60 days from the date of invoice.

Dishonoured Cheques

A surcharge of £15 +VAT will be made if a cheque, standing order or banker's order fails to clear the customer's bank account on each occasion.

Claims

No liability is accepted for any claims for short delivery or damage unless notified to us within 24 hours of delivery and in the event of damage, the delivery documents must be endorsed accordingly.

Consequential Loss

The Seller shall not, in any event, be liable to the Buyer for any indirect or consequential loss or damage.

Warranties

Solar cannot accept any liability whatsoever in respect of the usage to which the goods are put. The customer and any user should accordingly take all such steps to satisfy themselves of the suitability of the goods.

Returns

Goods being returned must have a completed Solar Tackle Returns Form with them - NO RETURNS WILL BE ACCEPTED IF SENT WITHOUT A COMPLETED RETURNS FORM. A Returns Form can be requested from Solar Tackle head office via phone or e-mail or from your Solar Tackle account manager.

Do not include orders or cheques in returned parcels. Goods accepted as faulty due to manufacture or material fault will be replaced or a credit note issued once inspected at Solar Tackle's headquarters. Any customer claim should, in the first instance, be referred to the original retail vendor who is responsible for resolving the claim with the customer. This does not affect a consumer's statutory rights.

A retail vendor who promises a refund, or to replace an item, before it has been examined by Solar Tackle does so at their own risk.

Retention Of Title

The Seller and the Buyer expressly agree that until the Seller has been paid in full for the goods comprised in this, or any other, contract between them:

- 1: The goods comprised in this contract remain the property of Solar (although the risk therein passes to the Buyer when the goods are delivered to the Buyer).
- 2: Solar may recover those goods at any time from the Buyer in his possession if the amount outstanding from the Buyer to the Seller in respect of goods supplied shall remain unpaid after the due date for the payment has passed; and for that purpose the Seller, his servants or agents may enter upon any land or building upon which the goods are situated.



Contact Details

Telephone: +44 (0)1322 277345

E-mail: sales@solartackle.co.uk

Online: www.solartackletrade.com

Office Hours

Monday to Thursday 8am - 5pm (GMT)

Friday 8am-4pm (GMT)

The office is closed on Saturdays & Sundays



Order on the Trade Website...
www.solartackletrade.com